

SET-UP SHEET

RACE	DHI Cup
TRACK	Arena Fyn
NAME	Rasmus Tobias Callesen
CITY/COUNTRY	Odense - Denamrk
DATE	4th to 6th January 2013

TEMPERATURE C	AIR 20-23 °	TRACK 20-23 °	
QUALIFYING POSITION	BEST LAP TIME 13.712 SEC	FINAL POSITION 18	RACE LENGTH 5 MIN
TRACK CONDITION	<input checked="" type="checkbox"/> CARPET	<input type="checkbox"/> ASPHALT	
	<input type="checkbox"/> TECHNICAL	<input checked="" type="checkbox"/> MIXED	<input checked="" type="checkbox"/> FAST
TRACTION	<input type="checkbox"/> LOW	<input checked="" type="checkbox"/> MEDIUM	<input checked="" type="checkbox"/> HIGH

FRONT		REAR	
TRANSMISSION			
GEAR DIFF	<input type="checkbox"/> CST	<input checked="" type="checkbox"/> 2000	CST
ONE WAY	<input type="checkbox"/>	<input type="checkbox"/>	<input type="checkbox"/>
SPOOL	<input checked="" type="checkbox"/>	<input type="checkbox"/>	SOLID
BALL DIFF		BALL DIFF	
<input type="checkbox"/> LOOSE	<input type="checkbox"/> MEDIUM	<input type="checkbox"/> TIGHT	<input type="checkbox"/> LOOSE
<input type="checkbox"/> MEDIUM	<input type="checkbox"/> TIGHT	<input type="checkbox"/> LOOSE	<input type="checkbox"/> MEDIUM
<input type="checkbox"/> TIGHT	<input type="checkbox"/> LOOSE	<input type="checkbox"/> MEDIUM	<input type="checkbox"/> TIGHT
MIDDLE SHAFT		FIXED <input checked="" type="checkbox"/>	ONE WAY <input type="checkbox"/>
PINION	38 T	SPUR GEAR	90 T
FINAL DRIVE RATIO	4,74	ROLLOUT	mm
MOTOR	LRP X12 13,5 T	TIMING	Blinky
ROTOR	Standard	ARMATURE	Standard
ESC	Hobbywing V3	BATTERIES	GM 6800 70C
BRUSHLESS	PROGRAM 0	PUNCH	INITIAL BRAKE -
0	0	0	AUTO BRAKE -
0	0	0	0
BODY	Serpent Lex-IS	WING	Standard

FRONT	SHOCK ABSORBERS		REAR
OIL	<input type="checkbox"/>	<input type="checkbox"/>	OIL
450 CST	<input type="checkbox"/> OPEN	<input type="checkbox"/>	400 CST
SPRING	<input type="checkbox"/>	<input type="checkbox"/>	SPRING
Grey	<input checked="" type="checkbox"/> CLOSED	<input type="checkbox"/>	White

THICKNESS	1,4 mm	ANTI-ROLL BAR	THICKNESS	1,4 mm
-----------	--------	---------------	-----------	--------

LRP CPX	TIRES	Handout
mm	DIAMETER	mm
Standard	INSERTS	preglued
AME MBT	ADDITIVE	25 minutes

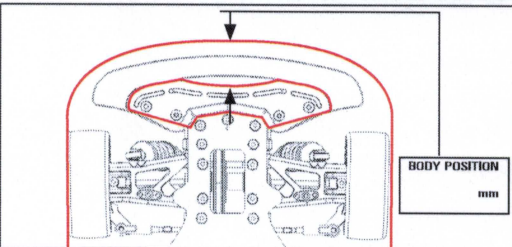

REMARKS
 Car = S411 Sport - part no. 400006
 Body = Lex-IS prepaint - part no. 401571

All car is stock out of the box except of:
 - springs - part no. 160297 and 160300
 - anti roll bar set - part no. 401575
 - oil in the dampers
 - oil in the differential
 - shims under the links

Link mount on the shock tower:
 - front: hole 1 of 3
 - rear: hole 2 of 4

FRONT

REAR

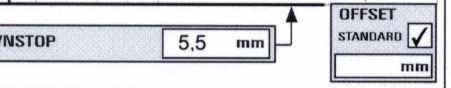
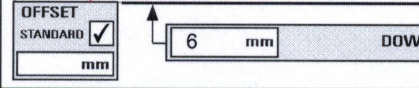
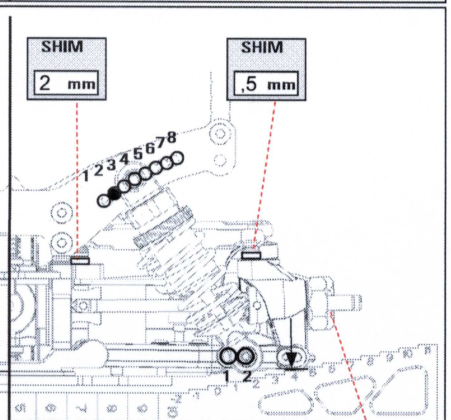
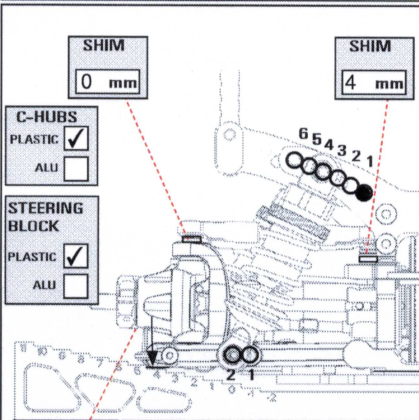
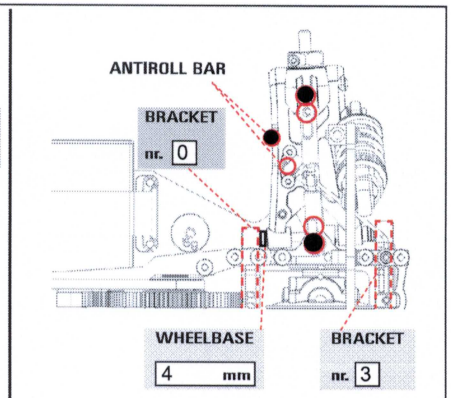
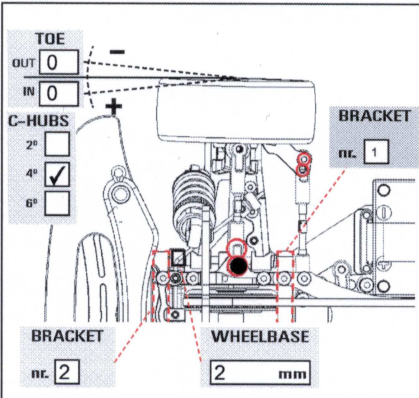

° 1.2 °	CAMBER	1.8 °
---------	--------	-------

