

SERPENT

MINI **SPYDER**



**FULL-SCALE HIGH-PERFORMANCE
HIGH -SPEED CAR**

ABOUT OFF-ROAD VEHICLES

With the 2.4G remote control technology adopted, buggy can be controlled from the remote controller to move forward and backward, turn left and right, speed up and slow down. Built with wide tires for better grip, powerful motor for strong power for smooth driving. The RC vehicle offers you a superior racing experience full of excitement thrill.

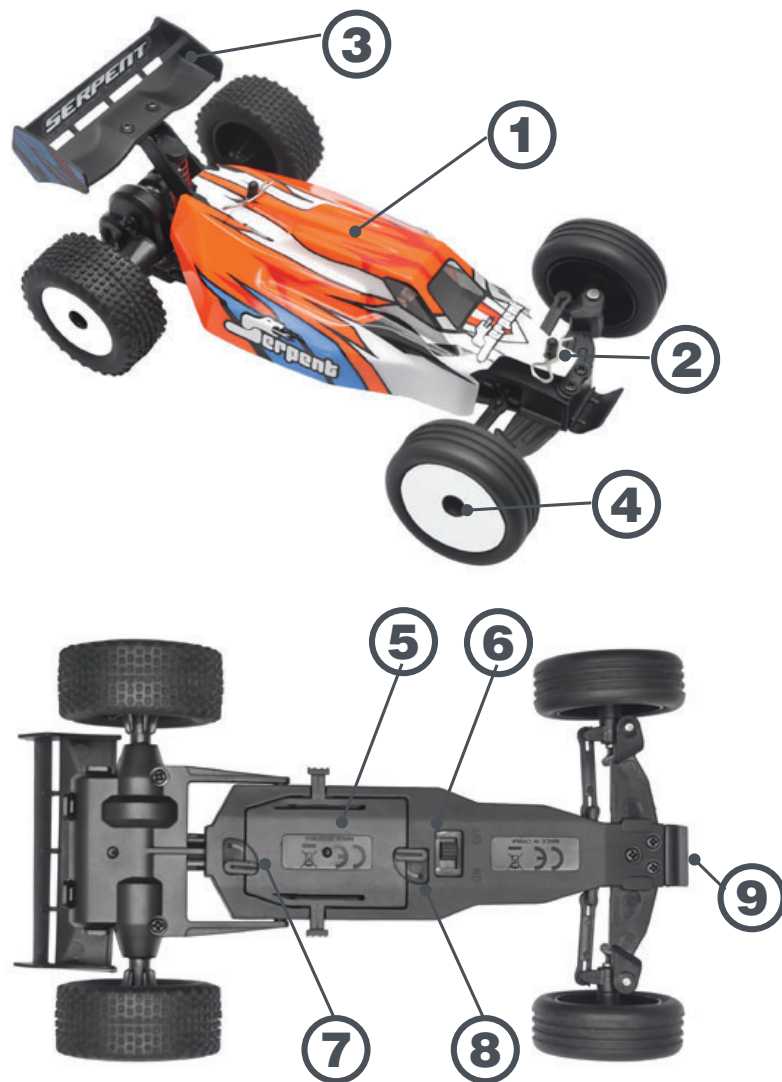

- | | | | |
|----|--------------------|----|--------------|
| 1. | Car body | 6. | Power Switch |
| 2. | Car body post | 7. | Battery lock |
| 3. | Car wing | 8. | Car chassis |
| 4. | Off road tyres | 9. | Bumper |
| 5. | Batery compartment | | |

OPERATING ENVIRONMENT

- Only run the car in designated areas or areas with very few people, so no-one can get hurt.
- The car has a lot of power and the turning parts on the car can cause damage, also some parts of the car like transmission and motor parts can become very hot. So wear protective clothing both as driver and helper and be careful when picking up the car.
- Do not operate the car under dark conditions, as both you and others may not see the car properly and can get hurt, due to lack of car control.
- Use good common sense while operating the car so you can fully enjoy your car.



INCLUDED WITH YOUR MODEL

- Serpent Spyder Mini off-road vehicle.
(battery included)



- Dragon-RC transmitter.



- USB Charger



- User manual

- Please check the number of accessories carefully. Please provide proof of purchase and contact the store for replacement if any missing parts.



1. Turn left.
2. Turn right.
3. Forward
4. Backward
5. Battery compartment.
6. Sideward fine-tuning.
7. Throttle ratio.
8. Power switch,
9. Power light.
10. Throttle fine-tuning.

TRANSMITTER BATTERY INSTALLATION

- ① Opening battery compartment cover with the clip.



- ② Open the cover of battery compartment and insert 2x AA batteries (not included).



- Ensure the polarity symbols on the batteries match the symbols inside the battery compartment. Do not mix new and old batteries. Do not mix different types of batteries.

PAIRING THE TRANSMITTER WITH THE RC VEHICLE

1



2

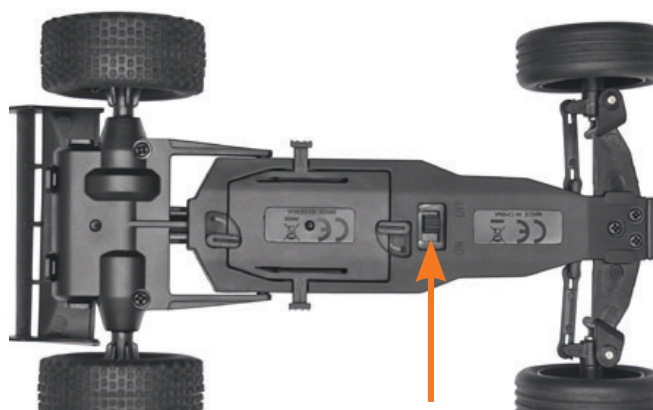

1. Pairing is the process of the remote control receiving the signal delivered by an exclusive ID from the transmitter. However, other radio signals are very likely to disrupt the process of pairing. Therefore, please turn off WiFi or 2.4G enabled devices before the pairing has been successful.
2. Power on the RC vehicle and then the transmitter. Then will be heard the sound of “di” and the transmitter red light turns solid, indicating the pairing has been successful.

BATTERY CHARGING

1

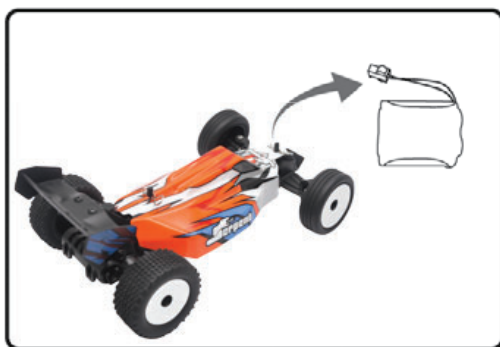

2

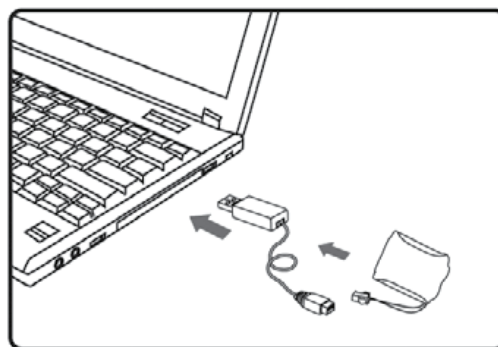

1. Take the battery out of the battery compartment.
2. Insert the USB charging cable into the adapter and connect it with the battery with the battery's positive and negative poles aligned correctly. The red light turns solid during charging and turns off when charging completes. Full charging takes about 40 to 50 minutes and plays for about 15-20 minutes.
3. Insert the battery into the battery compartment with its positive and negative poles aligned correctly and connect it with the connectors of the circuit board.

PRECAUTIONS

- The product is applicable for users aged 18 and above. For users under the age of 18, a parent or legal guardian shall company and supervise the child's use of this product at all times.
- Great care should be taken when using the electrical appliance. Adhere to safety instructions to avoid electrical shock.
- Please be aware any misbehaved actions would cause problems. Do not disassemble or modify the product.

OPERATIONS

1. For start the operation of the RC vehicle ALWAYS first Power on the transmitter and then RC vehicle (see figure 1). Ensure the transmitter's power light turns solid and the RC vehicle also.
2. Tilt the remote control to turn the RC vehicle's wheels to left or right (see figure 2). Then put the RC vehicle on the ground, stand behind it and squeeze the remote control's trigger to control other functions.
3. Slowly slide the trigger on the remote control (see figure 3) to control the RC vehicle to move forward or backward.
4. For finishing the operation of the RC vehicle ALWAYS first turn off the vehicle and finally turn off the transmitter to avoid control failure or control loss.



BATTERY INSTRUCTIONS

- There is certain risk when using a battery. It may cause fire, body or property loss. Users must be aware of the risks and take full responsibility of using battery improperly.
- If battery leakage occurs, please avoid contacting your eyes or skin with electrolyte. Once it happens, please wash your eyes with clean water and seek medical care immediately.
- Please remove the plug immediately if you sense any peculiar smell, noise or smog.

Battery charging

- Please use the charger from original factory to ensure your safe usage.
- Do not charge dilatatant or outworn battery.
- Do not over charge battery. Please unplug the charger once fully charged.
- Do not charge the battery next to inflammables, such as carpet, timber floor or wood furniture or on the surface of electro-conductive objects. Please always keep an eye on the battery when charging.
- Do not charge battery which not cool down yet.
- The charging temperature should be between 0° to 40°C.

Battery recycling

- Do not dispose the battery as daily rubbish. Please familiarize yourself with the local garbage disposal method and dispose it according to the special requirement.

REMOTE CONTROL DRIVING

Forward

In standby mode, pull the throttle trigger to control the RC vehicle forward.

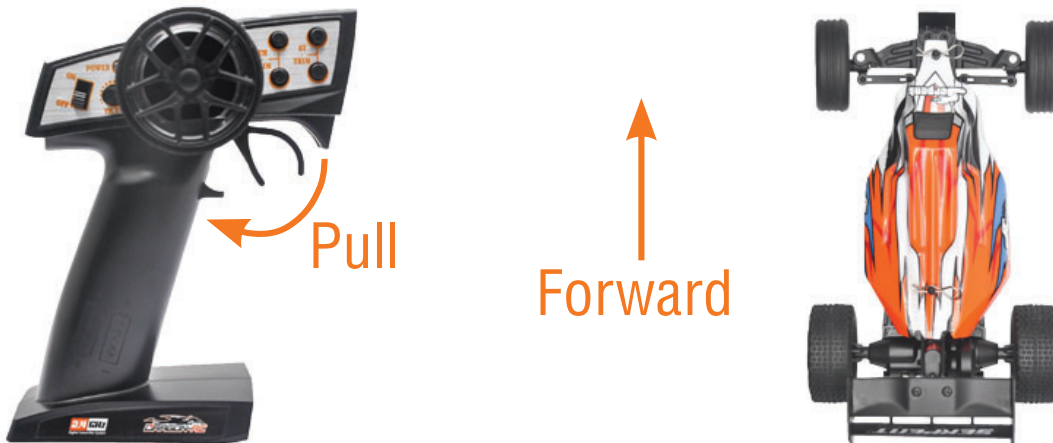

Backward

In standby mode, push the throttle trigger to control the RC vehicle backward.

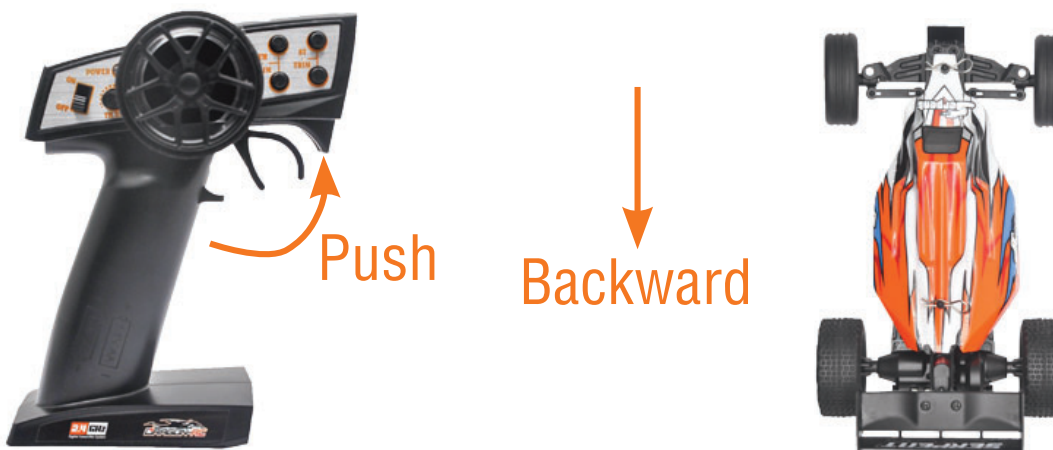

Turn left

Turn the steering to the left to control the RC vehicle to turn left.



Turn left



Turn right

Turn the steering to the right to control the RC vehicle to turn right.



Turn right



Fine-tuning

If the RC vehicle yaws, press the fine-tuning button to fine-tune its direction (shown as the picture).



Right Fine-tuning
Left Fine-tuning

Practise! Choose the area like the tower footing resistance (e.g. bottles) to practise. Try to drive fast on the straight lanes, while slowing down on bends.

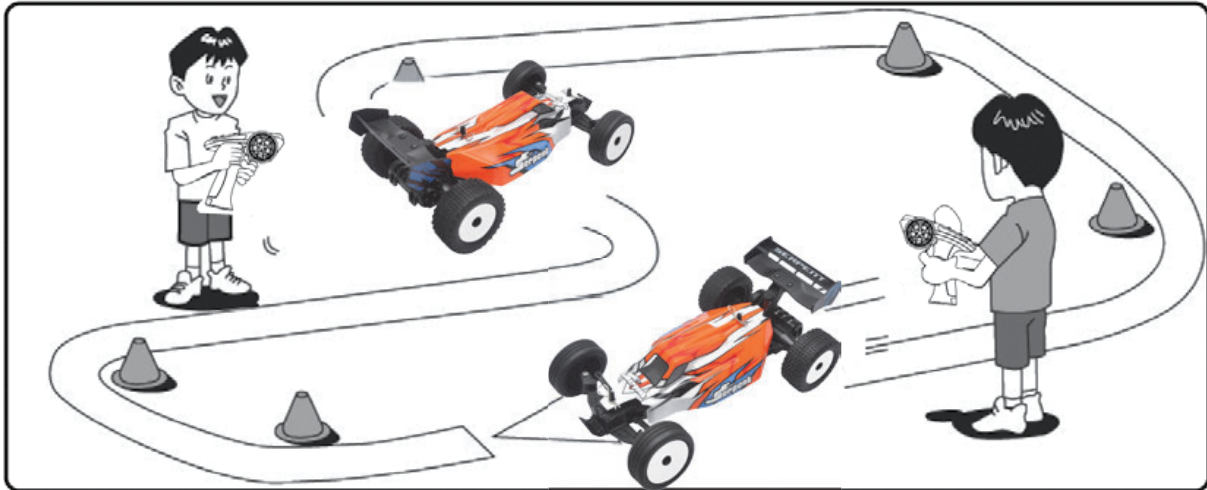

MAINTENANCE

1. Remove the battery from the car when the car is not in use.
2. Wipe out sands, muds, dust and clean the wheel axles.
3. Please apply anti-rust oil to the outer metal layer. (Anti dust oil is not included).
4. Store the car and the battery separately when the car is not in use.

COMMON PROBLEMS AND SOLUTIONS

PROBLEMS	CAUSES	SOLUTIONS
Wheels cannot spin.	“ON/OFF” not switched on yet. Low battery capacity. Pairing failed.	Slide the power switch to “ON” to power on Replace with new battery or charge the battery. Please re-pair complying with previous steps.
RC vehicle halts suddenly.	Low battery capacity.	Replace with new battery or charge the battery.
Power indicator light of the remote control flashes.	Low battery capacity.	Replace with new battery.
RC vehicle slows down.	Low battery capacity. Dirty wheel axle.	Charge the battery. Remove wheel and clean axle.
Fails to drive in straight line.	Fine-tuning mistakes.	Correctly fine-tune the position.

MINI SPYDER EXPLODED VIEW

